



W20 WIFI/GSM network alarm panel

W21 WIFI/PSTN network alarm panel

Content

1. Product Summary	(2)
2. Main Features.....	(2)
3. System Introduction.....	(3)
3.1. Panel Installation.....	(3)
3.2. Panel Introduction	(3)
3.3. Function Introduction.....	(3)
4. System Operation	(7)
4.1. Remote controller	(7)
4.2. PIR detector.....	(8)
4.3. RFID card	(8)
4.4. Wireless siren	(9)
4.5. Basic operation	(10)
5. Usage of APP Software.....	(13)
5.1. Install APP software	(13)
5.2. Register user account	(13)
5.3. Add device	(16)
5.4 .Popup notification.	(18)
6. SMS Query & Setting	(19)
6.1 Introduction	(19)
6.2 Modefy Panel Language	(19)
6.3 Help Order Format	(20)
6.4 Remote Operation Format	(20)
7. Technical parameters.....	(21)
7.1. Alarm Host.....	(21)
7.2. Remote Controller.....	(21)
8. Maintenance.....	(21)
8.1. Regular Testing.....	(21)
8.2. Cleaning Host.....	(21)
9. Solution of Simple Faults.....	(22)
10. Wireless door sensor	(23)
11.Infrared detector	(25)
The limitation of the security system.....	(27)

1. Product Summary

W20/W21 alarm system adopts the up-to-date digital sensor and transfer technology, which integrates burglar, and fire/gas protection for smart alarm system. W20/W21 adopts dot-matrix, voice, support IOS and Android app software. Users can remotely control and program the alarm host Via APP, also support multi-language. The system adopts WIFI/GSM、WIFI/PSTN wireless network digital signal processing technical. When alarm, it will inform alert via voice, information push, popup alarm on screen. W20/W21 Alarm System is a advisable choice for personal house 's security, working office's security and factory's security with fashionable appearance and multi-functions.

For a better service for users, please read this user's manual before installing and operating this alarm system.

We reserve the right to manual modification and explanation, so the manual changes without any prior notice.

2. Main Features

- ◆ WIFI and GSM dual- network transmission alert, two network backup mode selection. (W20)
- ◆ WIFI and PSTN dual- network transmission alert, two network backup mode selection. (W21)
- ◆ 32 wireless zones, and 11 Zones types are optional: disable, delay, burglar, smart Perimeter, fire, gas, duress, panic, medical, doorbell.
- ◆ Support to auto push messages about doorbell zone.
- ◆ Support 8 RFID card maximum, swipping to disarm. Content of each RFID card can be editable.
- ◆ 8 alarm numbers. Alarm phone type can be set in SMS, dialing or SMS & dialing. (W20)
- ◆ 8 PSTN alarm phone numbers, when alarm, will auto dial the preset phone number to inform user. (W21)
- ◆ Support IOS and Android APP software, user can operate and program alarm host via app software.
- ◆ Support arm/disarm, system, alarm information pushed in multi-language, alarm information pop-up on the screen, alarm voice and vibration.

-
- ◆ zone name can be edited by users, Check all states of the host in real time.
 - ◆ Intelligently connecting with network in short time, the host panel can be controlled by more than 1 mobile phone at the same time, joining networking center and centralizing monitoring of over 1 host panel with app. and also can share selectivity function to other user.
 - ◆ Support remotely updated the firmware by APP software.
 - ◆ Real-time monitor the open/close state of door and window, protecting the armed zone from failure with open door/window.
 - ◆ Built-in siren, the volume have three level can adjust, can work with wireless siren.
 - ◆ support remote operation by phone, support arm, disarm, monitoring and so on.
 - ◆ 2 arming/disarming timers can be set based on weekdays and weekends.
 - ◆ Built-in high power capacity 800mAh 3.7V lithium battery can be standby 8 hours at least.
 - ◆ Support 100 pieces of latest alarm records and querying via APP.

3. System Introduction

3.1. Installation

3.1.1. Panel Installation

The panel can be installed on desk or hanged on wall with an easy and convenient operation. Please install the bracket first before installing the panel on a desk or wall and make sure that the panel is installed in the center with good WIFI signal and wireless signal reception. Keep the panel away from big metal objects, high-frequency household appliances, concrete walls and firewall.

3.1.2. Wireless Detectors Installation

Instal the detectors in an effective distance from alarm host as the user's manual of wireless detector describes. Make sure to test the detectors and alarm system after installation.

Wireless transmitting function: when the alarm system may not receive the signal from wireless detectors due to far distance or wall-shading between wireless detectors and alarm host, the wireless repeater can be chosen to lengthen transmitting distance.

3.2. Panel Introduction

1. Front of panel

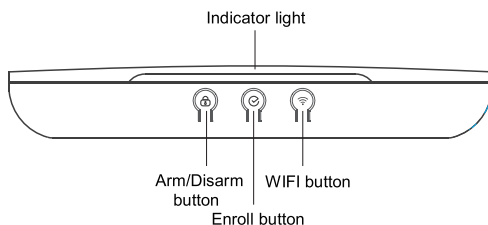
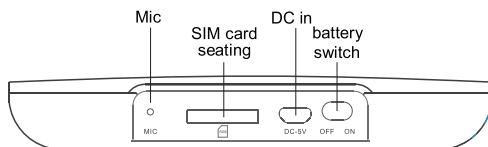

(W20)

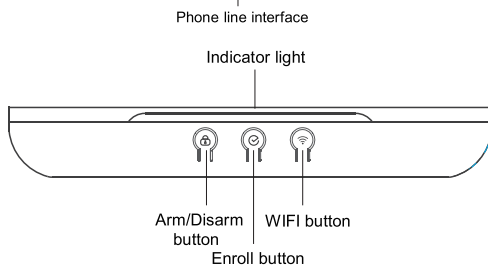
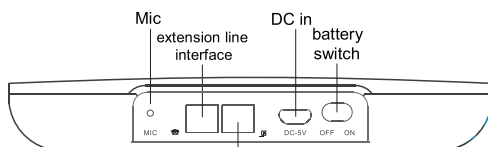

(W21)

Arm/Disarm: Shortly press to switch between away arm、home arm、disarm.

Enroll: Shortly press to query GSM working status. (W20)

Shortly press to query phone line status. (W21)

Long press to enroll wireless accessories.

WIFI button: Long press into WIFI intelligent networks status.

2.Indicator light

Status	Internet Connected	Panel Alarm	Router Connected	Internet Connecting
Away Arm	Red light long bright	Red light quick flashing	Red light flashes once	Red light slow flashing
Home Arm	Yellow light long bright	Red light quick flashing	Yellow light flashes once	Yellow light slow flashing
Disarm	Cyan light long bright	Red light quick flashing	Cyan light flashes once	Cyan light slow flashing

Indicator	Status
Green light	Enrolling
Violet light	Intelligently Internet Connecting
White light	Firmware upgrading
Blue light	GSM module status Phone line status

3. PHONE & LINE (W21)

Line interface is to connect with telephone line. phone interface is to connect with extension line. In order to send alarm report to user immediately by phone, user should connect telephone line with LINE interface. connect extension or other communication equipments with PHONE interface.

4. Prompt Voice illustration

Prompt Tone	Illustration
A short "Di"	Enrollment of wireless accessory succeeded Arm
A long "Di"	Wrong operation The wireless accessory has been repeatedly enrolled .
Two short "Di"	Correct operation Disarm
A short "Di"/s	Arm delay Alarm delay
A long "Di"/15s	Low power of battery Phone line fault

3.2.2. Function Introduction

1. Zone type

Zone Type	Alarm Delay	Output Alarm Voice	Arm	Disarm
Bypass	x	x	x	x
Delay	√	√	√	x
Burglar	x	√	√	x
Perimeter	x	√	√	x
Fire	x	√	√	√
Gas	x	√	√	√
Duress	x	x	√	√
Panic	x	√	√	√
Medical	x	√	√	√
Doorbell	x	x	x	x
Smart	x	√	√	x

Smart zone: The host won't ring alarm at once when detector in the zone get triggered by 1 time, it will ring alarm if detector get triggered again in the same zone within 40s.

2. Swiping RFID card to inform

The user can swipe RFID card to disarm, and host will send the RFID card notification to user mobile phone .

3. Door open/close function

3.1.door Open/Close

User can set door open/closed function for any zones to avoid arming failure when door's open. When door open/closed setting is enabled/activated, all doors/windows should be closed to arm.

3.2. Force arm

When user wants to arm the zones with open door, it needs to enable the force arm function. When arming compulsively, the zones with open door are disabled. Only the door is closed, the zones will work normally.

3.3. Doorbell zone

When set as "doorbell zone", control panel will ring "Ding-dong" if sensors got triggered under "disarm " or "home arm "status. control panel will not only ring "Ding-dong" but also auto push messages to user's mobile phone if sensors got triggered under "away arm" status.

4. System Operation

4.1. Remote controller

1. Enroll remote controller

Under the normal status without alarm event, long press “Ⓢ” button for 3s until hearing a short “Di” from Host and indicator light color turn in Green, it enters remote controller enrolling status, then user can start to trigger the remote controller to get it enrolled. To go enroll next remote controller, press “Ⓢ” button to go enroll next one. If the current indicator light is flashing, it means the current remote controller has not yet been enrolled and user can trigger remote controller to enroll. If enrollment succeeded, the host will prompt a short “Di”, meanwhile the indicator light will turn flashing into long bright, it means enrollment of remote controller is successful. If the current indicator light is long bright, it means the current address has been already enrolled. User should delete previous one before re-enrolling.

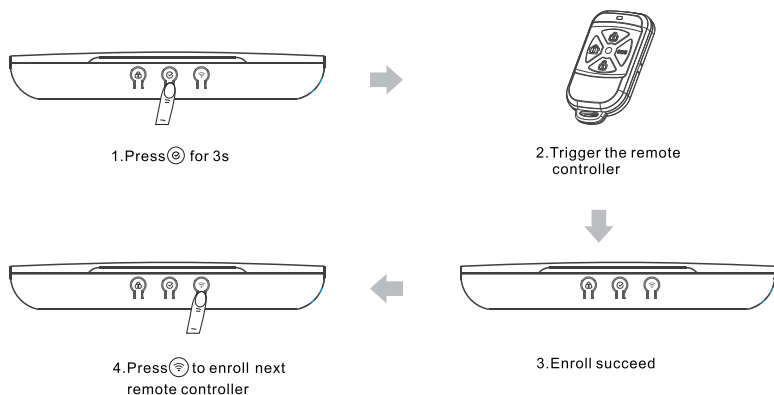

Note: If heard a long “Di”, it means the remote controller has already been enrolled.

2. Delete remote controller

In remote controller enrolling status, press “Ⓢ” button for 3s to delete the existing remote controller. After user heard two short “Di” from host and the indicator turn long bright into flashing, deletion is successful.

3. Exit Remote Controller enrollment

In remote controller enrolling status, short press “Ⓢ” button 4 times to exit.

4.2. Detector

1. Enroll PIR detector

Under the remote controller enrolling status, short press “⊕” button one time, then host enters the detector enrollment. Then short press “⊕” button into the next zone, If the current indicator light is flashing, it means the current detector has not yet been enrolled and user can trigger the signal of detector to enroll. If enroll succeeded, host will prompt a short “Di”, meanwhile the indicator light will turn flashing into long bright, it means successful enrollment of detector. If the current indicator light is long bright, it means the current address has been already enrolled. User should delete previous one before re-enrolling.

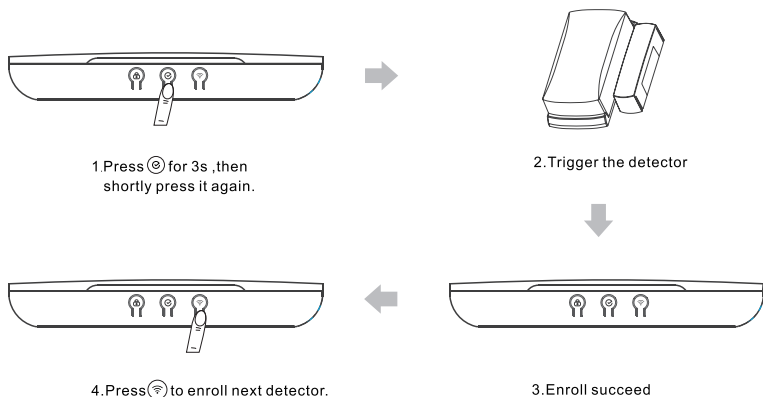

Note: If heard a long “Di”, it means the detector has already been enrolled.

2. Delete Detector

In detector enrolling status, press “⊕” button for 3s to delete the existing detector. After user heard two short “Di” from host and the indicator turn long bright into flashing, deletion is successful.

3. Exit Detector Enrollment

In detector enrolling status, short press “⊕” button 3 times to exit.

4.3. RFID card

1. Enroll RFID card

Under the remote controller enrolling status, short press “⊕” button twice, host

enters the RFID card enrollment. Then press “

1. Shortly press  3 times

2. Swiping the RFID card

3. Enroll succeed

4. Press  to enroll next RFID card.

Note: If heard a long “Di”, it means the RFID card has already been enrolled.

2. Delete RFID Card

In RFID card enrolling status, press “

3. Exit RFID Card Enrollment

In RFID card enrolling status, short press “

4.4. Wireless siren

1. Enroll wireless siren

Under the remoter controller enrolling status, short press “

9

means the current wireless siren has not yet been enrolled and user can trigger it to enroll. If enrollment succeeded, host will prompt a short “Di”, meanwhile the indicator light will turn flashing into long bright, it means successful enrollment of wireless siren. If the current indicator light is long bright, it means the current address has been already enrolled. User should delete previous one before re-enrolling.

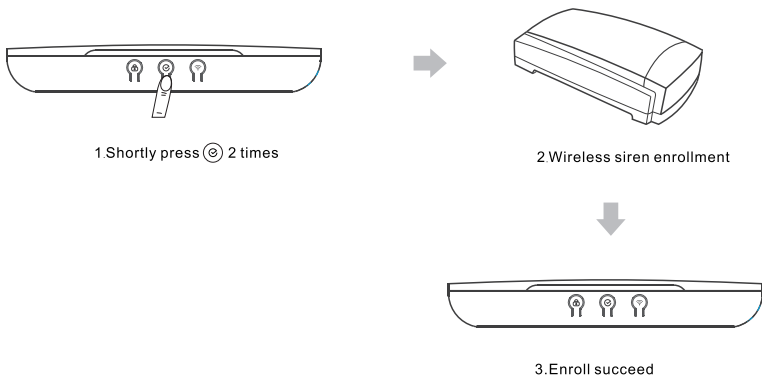

Note: Wireless siren can also be enrolled with host by manually inputting wireless address code at APP of mobile phone, when user chose to enroll wireless siren in 2 ways, Triggered the signal of wireless siren to enroll is preferred.

2. Delete wireless siren

Under the wireless siren enrolling status, press “” button with 3s to delete wireless siren, after user heard two short “Di” and indicator turn long bright into flashing, deletion is successful .

3. Exit wireless siren

In wirelss siren enrolling status, short press “” button one time to exit.

4.5. Basic operation

4.5.1. Remote controller

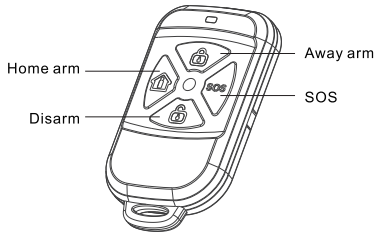

1. Away Arm

Away arm means when nobody is at home, home needs all around protection. When away arming is enabled, all detectors will be keep alert, so when something or somebody (fire, gas, theft) trigger the detector, panel will ring an alarm at once.

2. Stay/home Arm

Stay/home arm means when somebody at home, they want the outdoor detectors to keep alert, including door, window or balcony detector, while indoor detectors are dumb. So they will choose home arm function, which means part of detectors are keeping alert, while the others are not. Importantly, before enabling the home arm function, user need to add the detectors which you need them to keep alert in the zones into home arm list on app

3. Disarm

Disarm refers to terminate alarm or enable all the detectors not to work. In the disarming status, when the detectors are triggered, panel will not to give an alarm. (except the 24 hours zone type)

4. Emergency Alarm

When emergency happens, press the SOS button on remoter controller into alarm status.

4.5.2. Recovery of Factory setting

As soon as host charges the power, press "Ⓜ" button and "📶" button together within 15s, till the host prompt two short "DI", then factory setting is recovered.

4.5.3. Query GSM module/phone line status

Under standby status , short press “Ⓢ” button , enter the GSM module status instructions.(W20)

Indicator light	Status
Long bright	GSM module works normally
Quick flashing	GSM module fault or initializing failure
Slow flashing	GSM module has weak signal or no signal

Under standby status , short press “Ⓢ” button , enter the phone line status instructions.(W21)

Indicator light	Status
Long bright	Phone line works normally
Quick flashing	Phone line fault

4.5.4. Factory setting:

Arm/disarm information push: close

System information push: open

32 zone type : Burglar

The time of Arm delay: 0s

The time of alarm delay: 15s

PSTN fault detection: close

The dial times of phone: 5 times

The vibration of phone: 0 time

The volume of siren: High

The arm/disarm siren prompt: close

Alarm duration: 5minuts

Wireless siren: close

Arm/disarm timing: close

Open/close door: close

4.5.4 Answering alarm call & remote operation

1. Answering alarm call (W20/W21)

When alarm happens, panel will automatically call to the preset number. When users answer alarm call, panel will send voice alarm report to users. After that, there are 5s for users to input Instruction (table 1) by phone keypad. If users have no any

operations after answering, the panel will reply the voice alarm report for three times and then hang up automatically.

Note: when user opens monitoring, panel will force closing the siren automatically.

If there are no any operations within 60s, panel will hang up automatically.

2. Remote Control by Phone (W21)

User dials panel's telephone number or mobile phone number on remote, after panel rings reaching the maximum preset times, panel will be automatically off-hook. Then user can hear a short "Di" on phone. At this time, input [user password][#], if operation is correct, a short "Di" will be heard, and following related operation can be done (refer to table 1). if a long "Di" is heard, it means the input operation is false and user should re-input.

Note: If there are no any operations within 60s, panel will hang up automatically.

The user must set the Ring time as any value but zero.

Table 1:

Instruction	Implication	Instruction	Implication
1#	Away arm	7#	Open/close monitoring
2#	disarm	8#	Open/Close Intercom
5#	Open siren	0#	Hand up
6#	Close siren		

(W20)

Instruction	Implication	Instruction	Implication
1#	Away arm	6#	Close siren
2#	disarm	7#	Open/close monitoring
5#	Open siren	0#	Hand up

(W21)

5. Usage of APP Software

5.1. App installation

Scan the the following QR code, or users can search the key word "Smart Alarm", "Smart", "Alarm" at "APP store", "Google Play" to download and install.



IOS



Google Play



Android

5.2. Register account

Enter the APP software, register one account. Registered as follow:

Click the[Registrar]- input register information - click[Registrar].

The screenshot shows the 'Account login' screen. At the top, there is a user icon. Below it are two input fields: 'Input user name/mobile phone' and 'Input password', each with a magnifying glass icon. Under the password field, there are two checkboxes: 'Save Pwd' and 'Auto Login'. A 'Login' button is centered below the fields. At the bottom, there are two links: 'Forgot Password' and 'Register'.

The screenshot shows the 'Reset password' screen. At the top, there is a refresh icon. Below it are four input fields: 'Input user name/mobile phone', 'Input the encrypted email', 'Input new password', and 'Input new password again', each with a magnifying glass icon. Below the last field, there is a checkbox labeled 'Show password'. A 'OK' button is centered at the bottom.

Note: pls save email address, once you forget password you can set new password via email.

5.3. Add device

The process of adding device helps host to get the WIFI connecting password, and add it to the device list at app.

1. Enter the app [Add Device] page, choose[WIFI network Device], go into the connect network alarm host page.

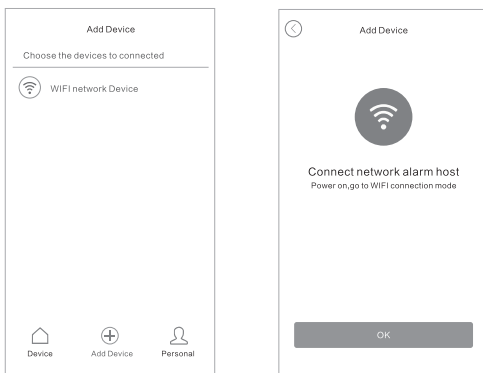

2. Long pressing host  button for 3s, the host go into the network connection mode, meanwhile the indicator light will turn into violet light and flash slowly.

Note: When WIFI module is initialized, long press host  button for 3s, the host will prompt long "DI", it means the host unable to go connect network mode, so the user must try again same operation is ok.



3. On the connect network alarm host page ,choose [next], go into WIFI input password page. After input the WIFI password ,then choose [next], go into the connect network page. APP will start count down 100s for connect time, when connection succeed, go into the successful page. when connect fail,go into the connect fail page, the user need click [Retry], connect again.

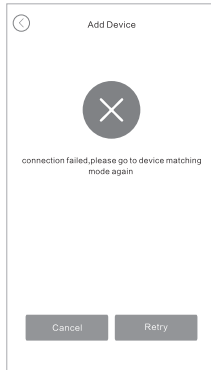
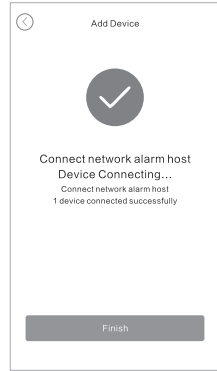
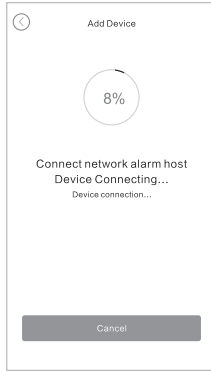
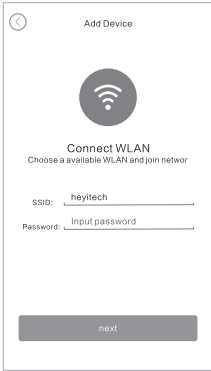

Note: Connect network must be processed and requiring the APP and host under same WIFI environment.

5.4. APP usage

1. App home page

On[Device]page choose one device, go into the device home page, operate arm/disarm.

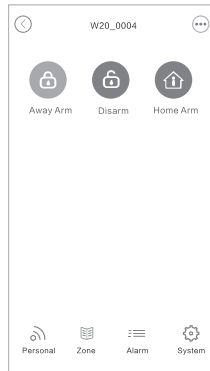

2. Device operation and programming

On device home page, click top right corner [Device Properties], the under page [Control], [Zone], [Alarm], [System], go into the operation page.

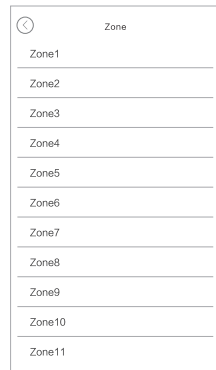
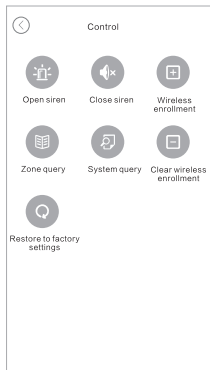
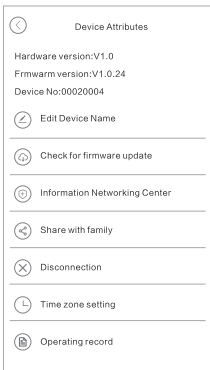

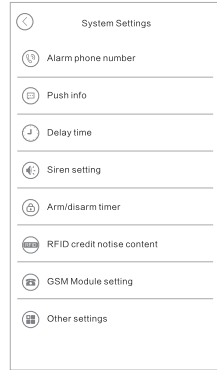
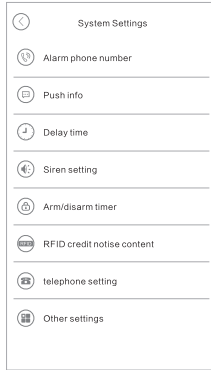
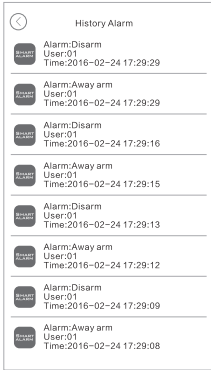

5.5. Push Notification

1. Alarm notification push

On Android app, when alarm notification push, the mobile will auto popup on the screen, with alarm sound and alarm vibration. On the alarm notification push screen direct click [Live Video] into IP camera app to check the video; click [View] into my device page. the ring time of alarm push can set at [Personal] --- [System setting].

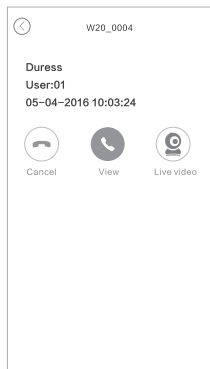

2. Arm/disarm information, system information push.

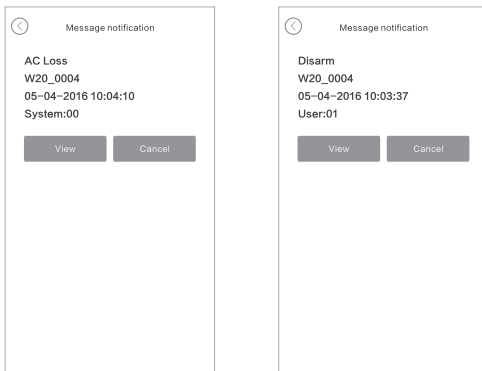

6. SMS Query & Setting

6.1 Introduction

SMS Order adopts that users send order to panel in advance, and panel send prompt message or setting module to users after receiving the order, then users can reply panel with needed setting data according to module format request. Or users can directly send the edited message to users according to the format request of module.

Note:

1. Please use the English input method punctuation when inputting punctuations.
2. Message setting includes some help contents and parameter ranges. Please modify them with the strict message format and ranges and do not add any unnecessary characters and blank spaces, add or delete line breaks in message and exceed the limited inputting digits.
3. If the message users sent is not fitted for the panel's format or range, panel will reply "Setting failure, wrong input order format or informal characters" to users.

6.2 Modify panel language

Item	SMS by User	SMS Reply by Panel
Simplified Chinese	Program Password,0086	设置简体中文语言成功!
English	Program Password,0001	Set English successfully!

6.3 Help order format

Item	SMS by user	SMS reply by panel
SMS Help Index	Program Password,?	01: Away arming 02: Stay arming 03: Disarming 04: Monitoring 05: Open siren 06: Close siren 07: Time calibration 08: System query

6.4 Remote operation format

Item	SMS by User	SMS Reply by Panel
Away arming	Program Password, 01	Away arm successfully
stay arming	Program Password, 02	Delay arm successfully
Disarming	Program Password, 03	Disarm successfully
Monitoring	Program Password, 04	
Open siren	Program Password, 05	Open siren successfully
Close siren	Program Password, 06	Close siren successfully
Time calibration	Program Password, 07	Set Time calibration successfully X X X X - X X - X X X X : X X : X X X X X
System query	Program Password, 08	X X - X X X X : X X : X X Status: Stay arm/Away arm/ Disarm AC power: Normal/ Fault Panel battery: Normal / Low GSM signal: 0-5
Delete all wireless accessories and RFID cards	Program Password, 98	All wireless accessories and RFID cards are deleted successfully!
Restore factory setting	Program Password, 99	The system has been restored factory setting!

7. Technical parameters

7.1. Alarm host

Size: 141mm×140mm×25mm (L×W×H)

Power: AC100V~240V

Battery: 3.7V/800mAh

Built-in siren: >80dB(within 1M)

GSM Working Frequency: 850MHz, 900MHz, 1800MHz, 1900MHz (W20)

GSM Emitting Frequency: ≤2W(850/900MHz), ≤1W(1800/1900MHz) (W20)

WIFI standard: 802.11 b/g/n

WIFI frequency: 2.4G

WIFI encryption mechanism: WEP/WAP-PSK/WPA2-PSK

Networking protocol: IPv4,TCP/UDP/HTTP

Wireless working frequency: 433MHz

Wireless distance:

Between wireless PIR detector and alarm panel: ≥400m (in the open area)

Between wireless door sensor and alarm panel: ≥200m (in the open area)

Between wireless remote controller and alarm panel: ≥100m (in the open area)

Between wireless siren and alarm panel: ≥300m (in the open area)

Working temperature: -10℃ - +50℃ humidity: 40 ~ 70%

7.2. Remote controller

Power: Battery CR2016 2pcs

Standby current: ≤1uA

Transmitting power: ≤10mW

Transmitting frequency: 433MHz

8. Maintenance

8.1. Test timer

It is suggested to test the system one time per month to make sure the normal working of system. If there is anything wrong, please at once contact with working people.

8.2. Cleaning panel

Please take cotton cloth or sponges with water to clean the alarm unit.

Note: Do not use anything with organic solvents to clean the panel, such as coil oil, superglue, etc, lest should destroy the panel.

9.Solutions for Simple faults

Troubles	Reason Analysis	Solution
Host can't alarm by phone	<ol style="list-style-type: none"> 1.no arm 2.no set alarm phone 3.wireless accessory has not yet been enrolled 	<ol style="list-style-type: none"> 1.arm 2.reset alarm phone 3.enroll I again
Remote controller doesn't work	<ol style="list-style-type: none"> 1. remote controller has not yet been enrolled 2.low power 	<ol style="list-style-type: none"> 1.enroll again 2.change the battery
Door sensor doesn't work	<ol style="list-style-type: none"> 1.Installation site of Emitter and magnet is wrong 2.Door sensor has not yet been enrolled 	<ol style="list-style-type: none"> 1.when door sensor separate the light is on 2.enroll again
PIR detector doesn't work	<ol style="list-style-type: none"> 1.PIR in lock status 2.The distance of PIR is too long 3.The PIR has not yet been enrolled 	<ol style="list-style-type: none"> 1.Learning the PIR work principle 2.Adjust PIR position 3.enroll again
Wireless detectors are often triggered wrongly	installation site doesn't conform with right condition	change the installation site
One long "Di"/15s	<ol style="list-style-type: none"> 1.low battery power of wireless detector 2.Invalid SIM card (W20) 3.Phone line fault (W21) 	<ol style="list-style-type: none"> 1.change the battery of detector 2.Insert valid SIM card (W20) 3.Phone line detection(W21)
Host can't connect with router	<ol style="list-style-type: none"> 1.the router can't surf the Internet 2.Open the MAC address access restrictions 3.The router frequency is 2.4GHz or not 4.Host doesn't connect network 5.host network connection exception 6.Router use for a long time 	<ol style="list-style-type: none"> 1.Pls check the network connection status 2.Close the restriction function 3.Check the router frequency 4.connecting network configuration 5.Restart the host 6.Restart router
Make a phone call to the host can't connection	Host the phone ringing times is set to zero	The phone ringing times set to a non-zero value
Not sound when alarm happen	<ol style="list-style-type: none"> 1.The Siren volume set as silent 2.The zone type set as Duress 	<ol style="list-style-type: none"> 1.Change the siren volume 2.Change the zone type

10. Wireless door sensor

1. Instruction

With micro power consumption, high stability, long distance, battery can last long time. And have low power alert. The door sensor can be installed on door, window, and others which can open and close.

When intruder enters into detecting area, it sends alarm signal to alarm console. The wireless transmitting distance can reach 400 meters in open area. It suits for bank, villa, home residence, factory building, market, storehouse, etc.

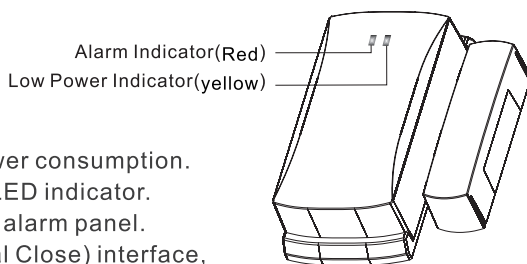

2. Features

- ⊙ Design by micro power consumption.
- ⊙ Low power alert by LED indicator.
- ⊙ Low Power report to alarm panel.
- ⊙ Support N/C (Normal Close) interface, can connect wired devices. (Optional)
- ⊙ Battery capacity inspection. When voltage of battery < 2.4V, the door magnet stop working. And the yellow light will be on.
- ⊙ Adopts SMT design to increase the stability.
- ⊙ support door open/closed notification.

3. Technical Specification

- ⊙ Power: DC 3V (2 pcs 1.5V/AAA Battery)
- ⊙ Standby Current: $\leq 3\mu\text{A}$
- ⊙ Alarming Current: $\leq 8\text{mA}$
- ⊙ Wireless Distance (with antenna): $\geq 400\text{m}$
Wireless distance (inner Antenna): ≥ 200
- ⊙ Wireless Emit Frequency: 433MHz.
- ⊙ Operation Temperature: $-20^{\circ}\text{C} \sim 60^{\circ}\text{C}$

- ⊙ Operation Humidity: $\leq 80\%$
- ⊙ Sensor Dimension(L*W*H): 79*37*20.5mm
- ⊙ Magnet Dimension(L*W*H): 56*14*15.5mm

Electric Circuit Sketch:

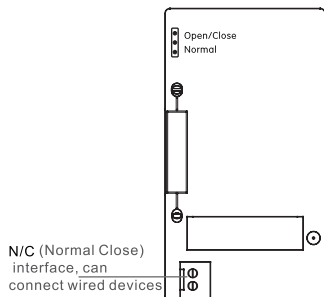

Open /Close: it will transmit signal when magnet and sensor are either separated or closed.

Normal: it will only transmit signal when magnet and sensor are separated.

Assemble Sketch:

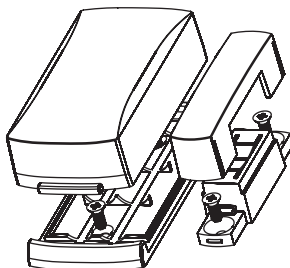

4. Installation

- ⊙ Open bottom cover of sensor, get insulated tape away, then it enters into working status.
- ⊙ Install sensor on doorframe, and magnet on door or window. Keep magnet at right side of sensor, use double sided tape or screw to fix.

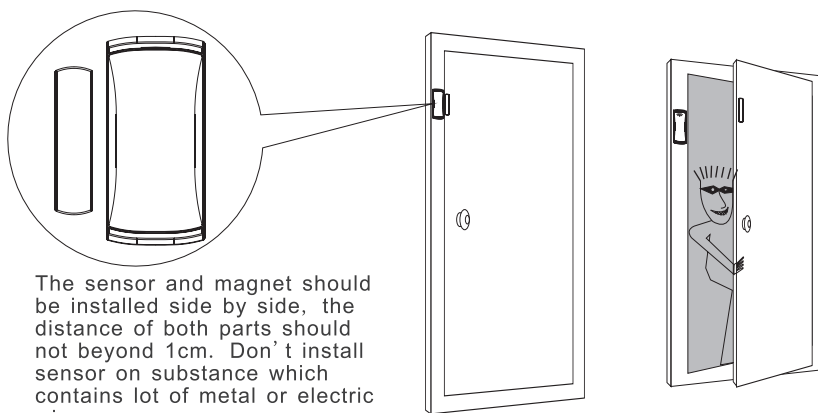

The sensor and magnet should be installed side by side, the distance of both parts should not beyond 1cm. Don't install sensor on substance which contains lot of metal or electric wire.

5. Note:

- ⊙ The product can reduce accident, but can't prevent anything. Except using this product correctly, please don't relax your vigilance, and improve safety consciousness.
- ⊙ When received Low Power Alert from sensor or panel, please change battery without delay to insure the alarm system working

11. Infrared detector

Brief Introduction

The Wireless Passive Infrared Sensor adopts advanced digital signal processing technology with automatic temperature compensation. It emits wireless digit signal to activate alarm host effectively when detecting human infrared heat energy. Low power consumption to ensure the battery lasts long time, and it ensures the system working stable and low rate of false alarm.

Products Features

- ⊙ Low power consumption
- ⊙ Automatic temperature compensation
- ⊙ anti-electromagnetism interference
- ⊙ anti-white light
- ⊙ Low power alert, and send low power report to alarm host
- ⊙ With SMT technology, high stability
- ⊙ Fashion appearance, easy installation

Technical Parameter

- ⊙ Detecting Way: Dual sensor with digital signal processing technology
- ⊙ Stand-by current: $\leq 30\mu\text{A}$
- ⊙ Detective distance: 8m.
- ⊙ Alarm current: $\leq 13\text{mA}$
- ⊙ Detective angle: 110°
- ⊙ Emission Frequency: 433.92MHz

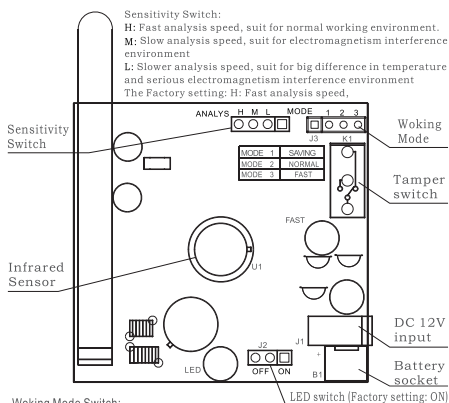

- ⊙ Working temperature: $-10^{\circ}\text{C} \sim 40^{\circ}\text{C}$ (indoor use)
- ⊙ Installation Height: 2 - 2.5m
- ⊙ Emission Distance: $\geq 450\text{m}$ (Inner Antenna $\geq 300\text{m}$) in open area.
- ⊙ Working Voltage: DC6V (4pcs 1.5V/AAA battery), or external power (adapter DV12V).
- ⊙ Dimension: (L*W*H) 100*56.5*44.5mm (Note: not including length of antenna)
- ⊙ Standard packing: 1pc detector, 1pc active bracket, 2pcs screws, 2pcs screw bolt, 1 user' s manual.

Detecting Range

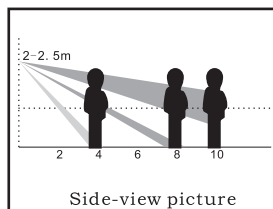
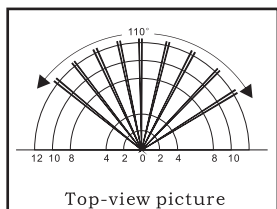

Installation

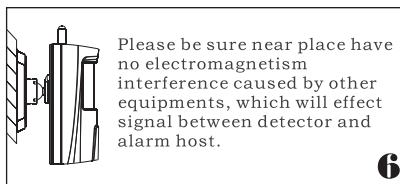
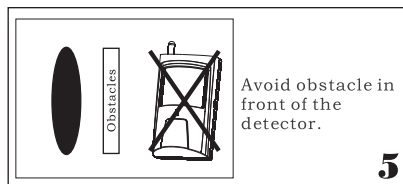
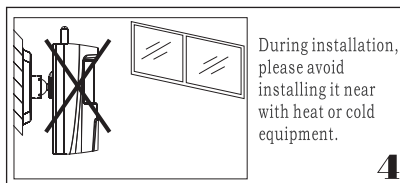
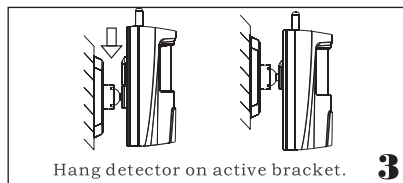
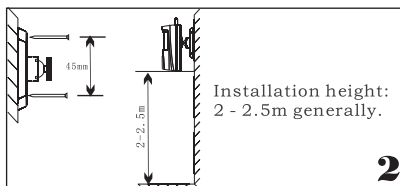
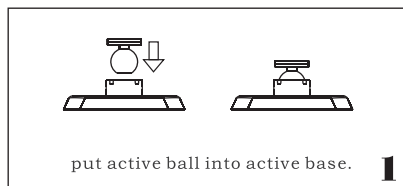

Operation

After installing battery, the detector will send report signal of power recovery. After sending report, the detector enters into preheat and self-check status with in 60 seconds, and the LED will flash every 2 seconds. After 60 seconds, the LED stops flashing, and enters into normal working status. Then users can go to test within its detecting area. If detecting people, the detector LED will light, and send signal send signal to alarm host. Users can adjust the detecting angle of detector according to their requirements.

Battery Test and Change

1. The detector can check working situation of battery voltage periodically. When finding low voltage of battery, it will send report to alarm host. Under low power, the detector can still work for some time, and LED will flash every 15s to indicate low power and needing to change battery.
2. During preheat and self-check time when installing battery, if battery voltage is low, the LED will flash quickly, and detector will not work. At this time, users need to change battery.

Attention

1. Please correctly use and install according to the user's manual. Don't touch surface of sensor, or it will affect sensitivity. If needing clean, please power off, and then lightly wipe by soft cloth with little alcohol.
2. Try to use the detector without big difference of temperature, to reduce false alarm rate.
3. This product can reduce happening of accident, but not sure no risk at all. For your safe, Except of using the product, please improve vigilance, and enhance awareness of security in daily life.

The limitation of this alarm system

While this system is an advanced design security system, it does not offer guarantee protection against burglar or fire or other emergency. Any alarm systems, whether commercial or residential, is subject to somewhat alarm failure or wrong alarm for variety of reasons.

For example:

1. Owing to the omission of user, the system was not armed.
2. Misunderstanding on the user's manual by the user or installer causes the abnormal working of the system.

-
3. Intruders may gain access through unprotected openings or have the technical sophistication to bypass an alarm sensor or disconnect an alarm warning device. Passive Infrared Motion Detectors can only detect intrusion within the designed ranges as diagrammed in their installation manual. They do not provide volumetric area protection. They can not detect motion or intrusion that takes place behind walls, ceiling, floors, closed doors, glass partitions, glass doors, or windows.
 4. Passive Infrared Detector sense changes in temperature; however, as the ambient temperature of protected area approaches the temperature range of 32°C to 40°C , the detection performance will decrease.
 5. It is exiting no-power or battery-aging.
 6. Alarm warning devices such as sirens, bells or horns may not alert people or wake up sleeper if they are located on the other side of closed or partly open doors.
 7. Telephone lines needed to transmit alarm signals from a premise to a central monitoring station may be out of service or temporarily out of service. Telephone lines are also subject to compromise by sophisticated intruders.
 8. The most common cause of an alarm system not functioning when an intrusion or fire occurs is inadequate maintenance. This alarm system should be tested weekly to make sure all sensors and transmitters are working properly.
 9. The wireless communication distance is the testing figure in open area. Please make sure no obstacle in the surrounding environment to guarantee the reliability of the wireless communication distance farther.
 10. The weak network signal may be caused by adjusting of carrier, busy network or unavailability of SIM antenna.
 11. If you disagree with the above mentioned items, please return the alarm system to our company within 3 days from purchasing. You will get a full refund if the alarm system without artificial damage. Or we will take it that you will agree with above items. Installing an alarm system may make one eligible for lower insurance rates, but an alarm system is not a substitute for insurance. Homeowners, property owners and renters should continue to act prudently themselves and continue to insure their lives and property.

WIFI BURGLAR ALARM SYSTEM

PRODUCT QUALITY GUARANTEE CARD

Model _____ Product number _____ invoice number _____ Purchase date _____

Date	Maintenance record

Notification: this product guarantee exchange within one month, and maintenance within its lifetime after purchased
(But not include man-made damage, exchange of damaged parts may charge fees)

